

Fig. 1. DePamphilis. From page 10.

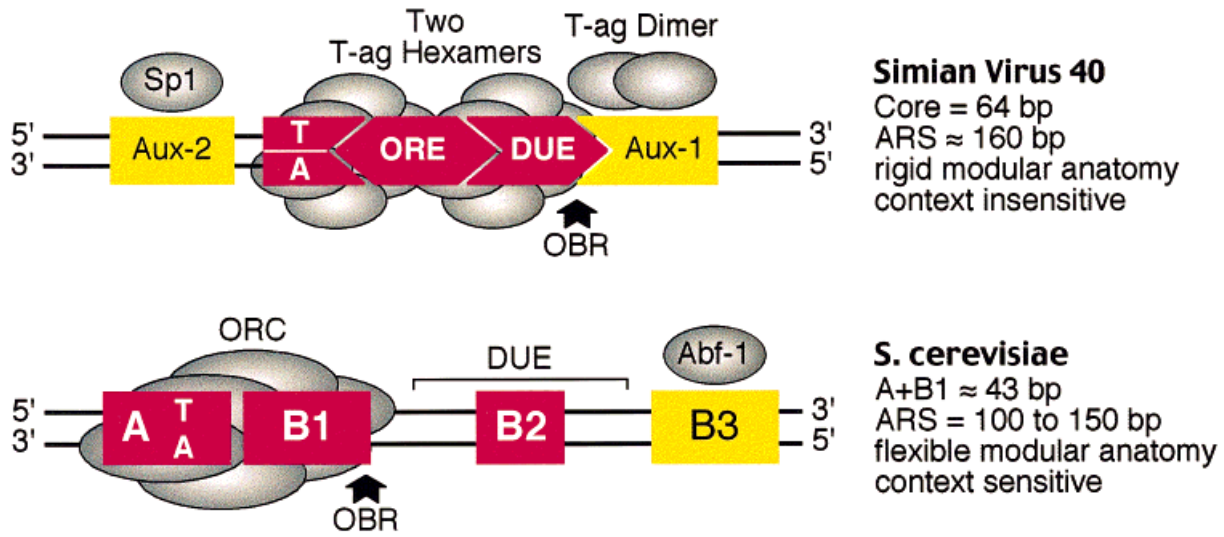

Fig. 2. DePamphilis. From page 11.

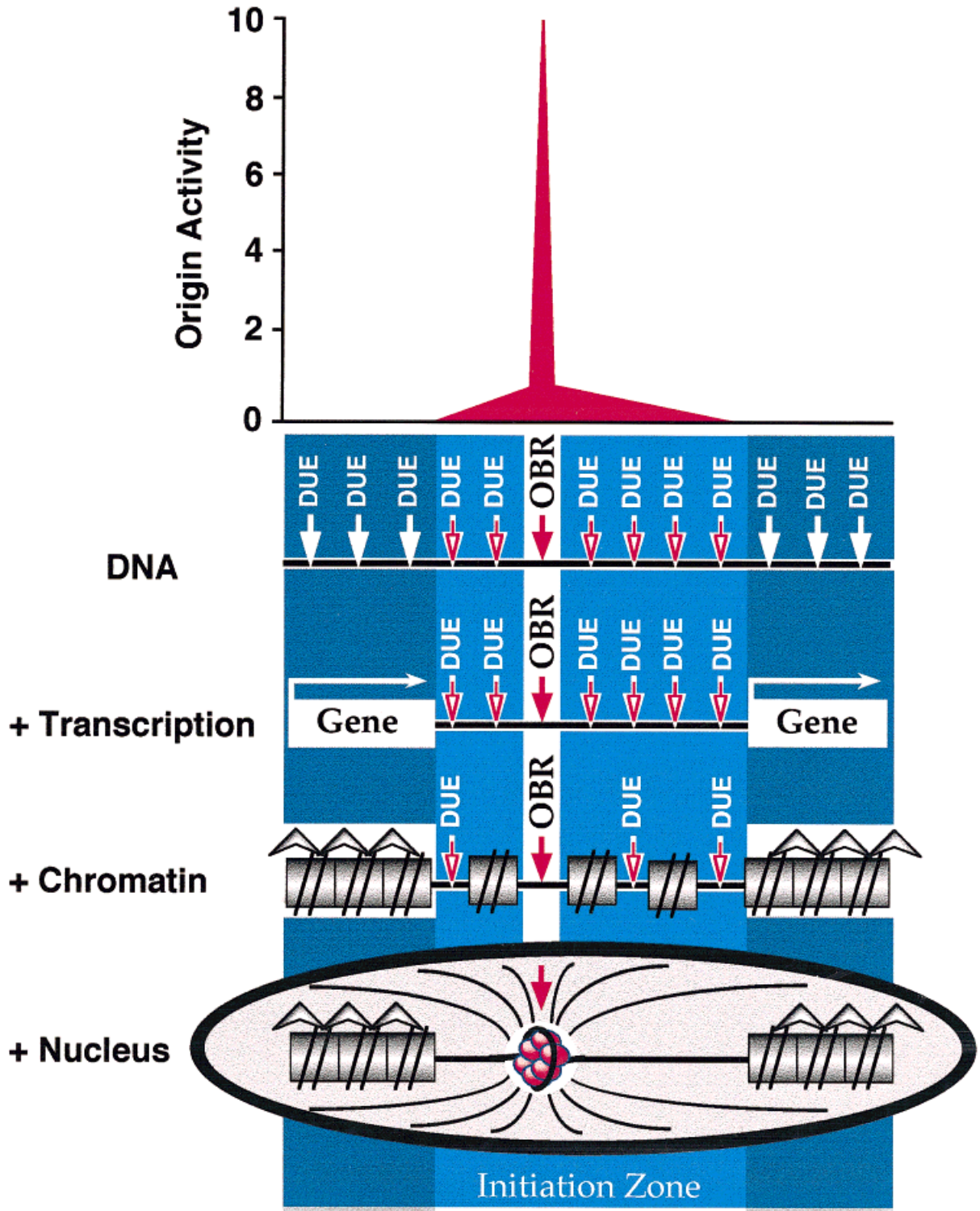

Fig. 3. DePamphilis. From page 14.

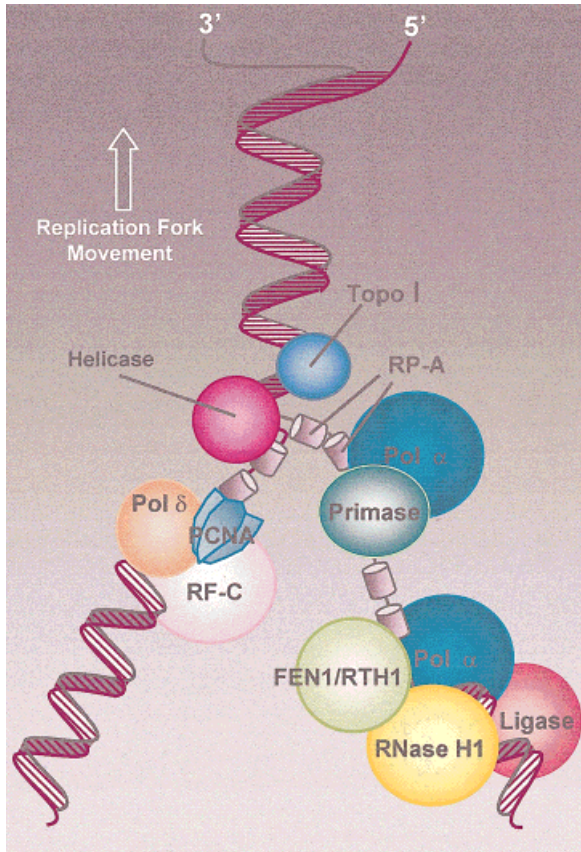

Fig. 1. Malkas. From page 19.

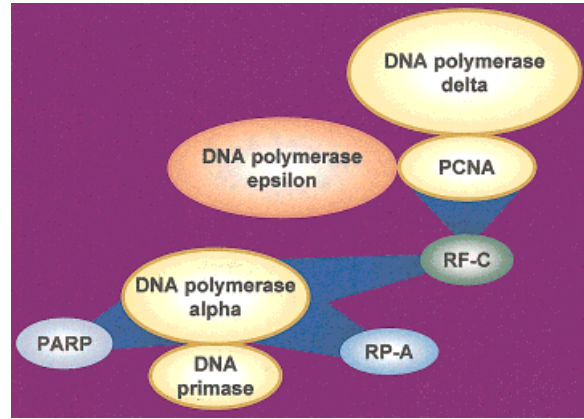

Fig. 3. Malkas. From page 25.

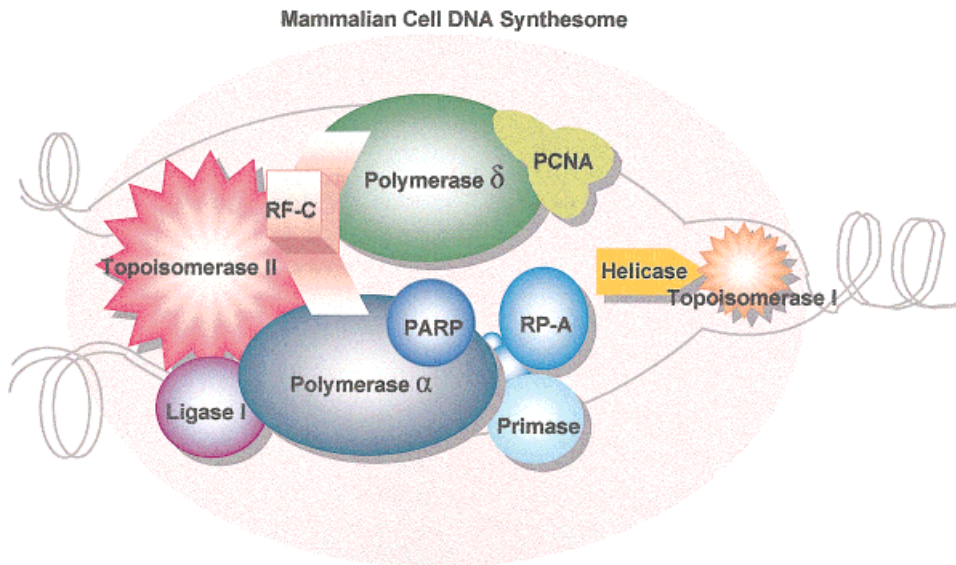

Fig. 2. Malkas. From page 25.

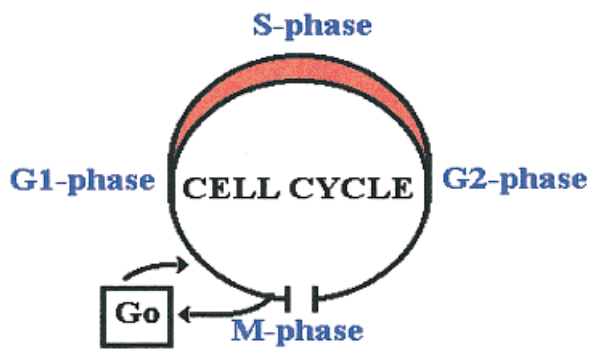

Fig. 1. Mercer. From page 51.

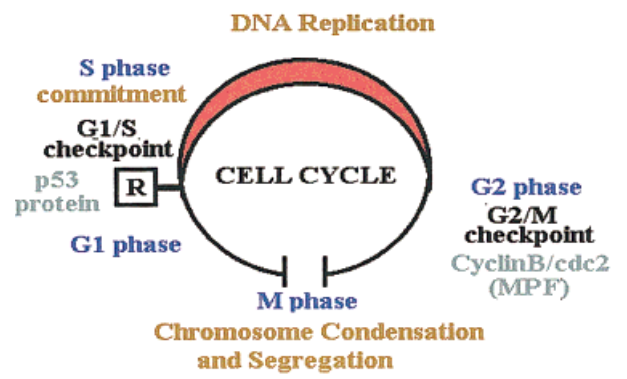

Fig. 2. Mercer. From page 52.

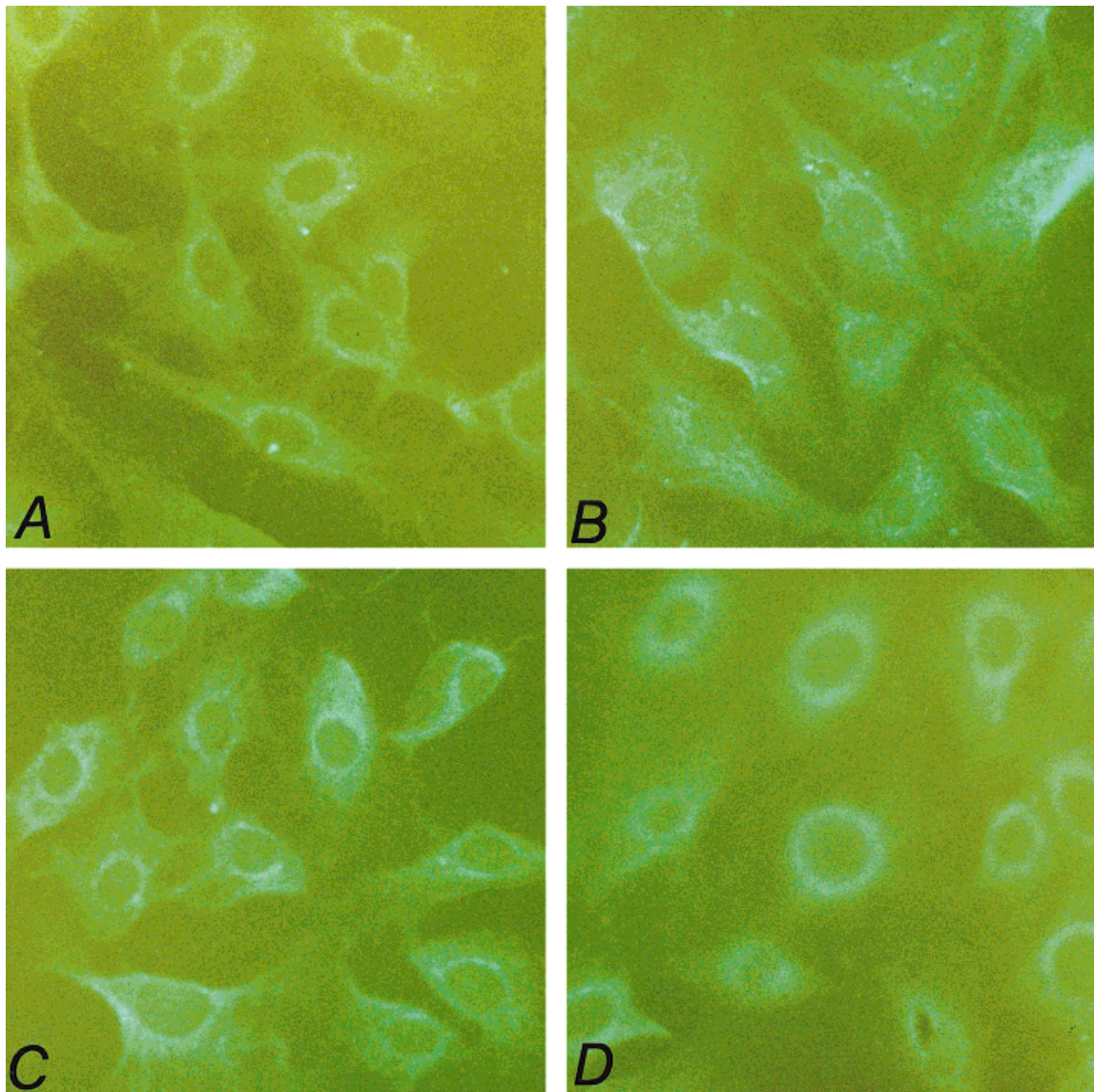

Fig. 2. Denhardt and Noda. From page 97.

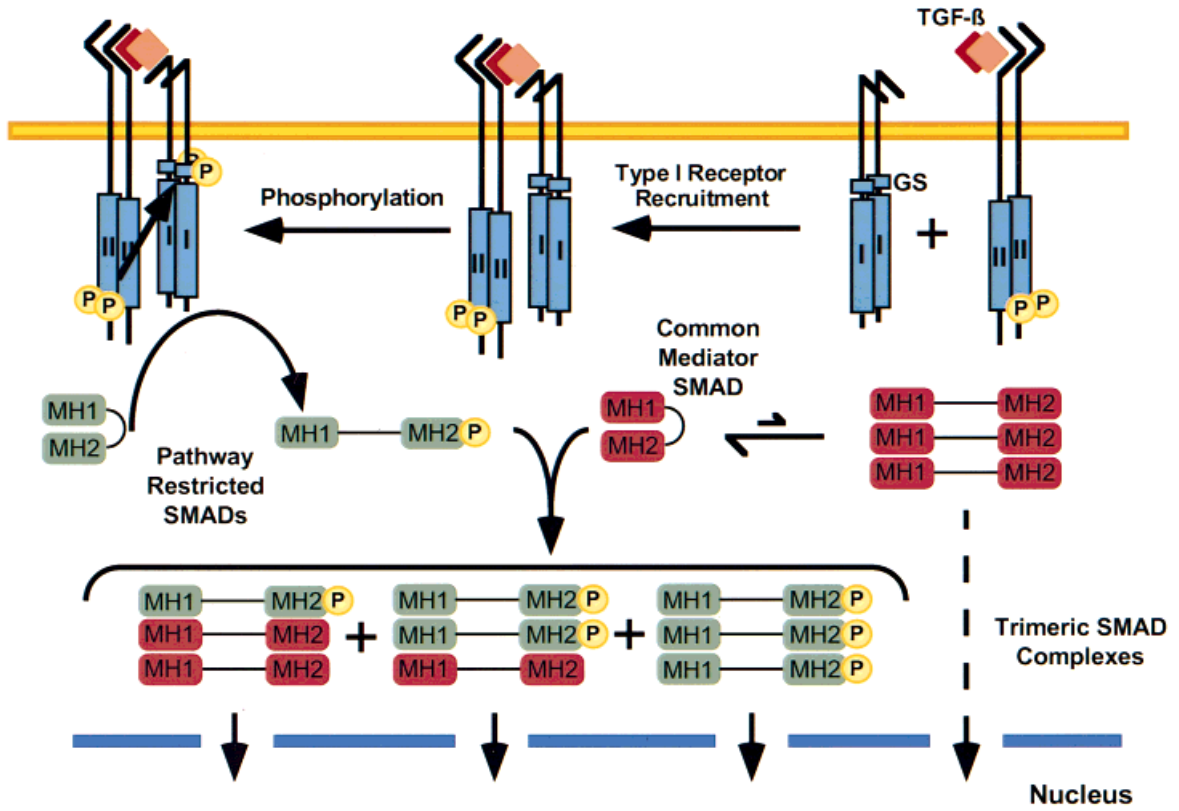

Fig. 2. Engel et al. From page 113.

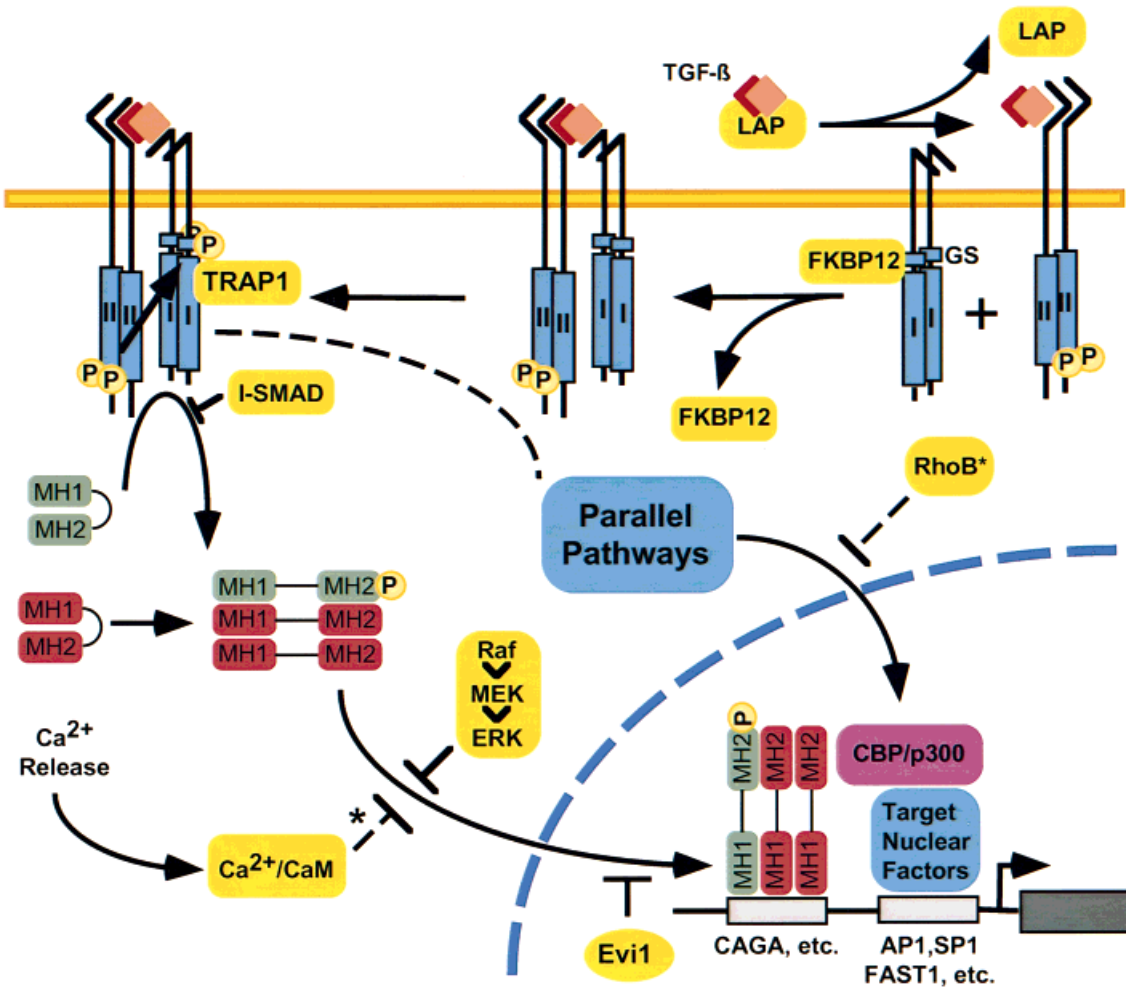

Fig. 3. Engel et al. From page 118.



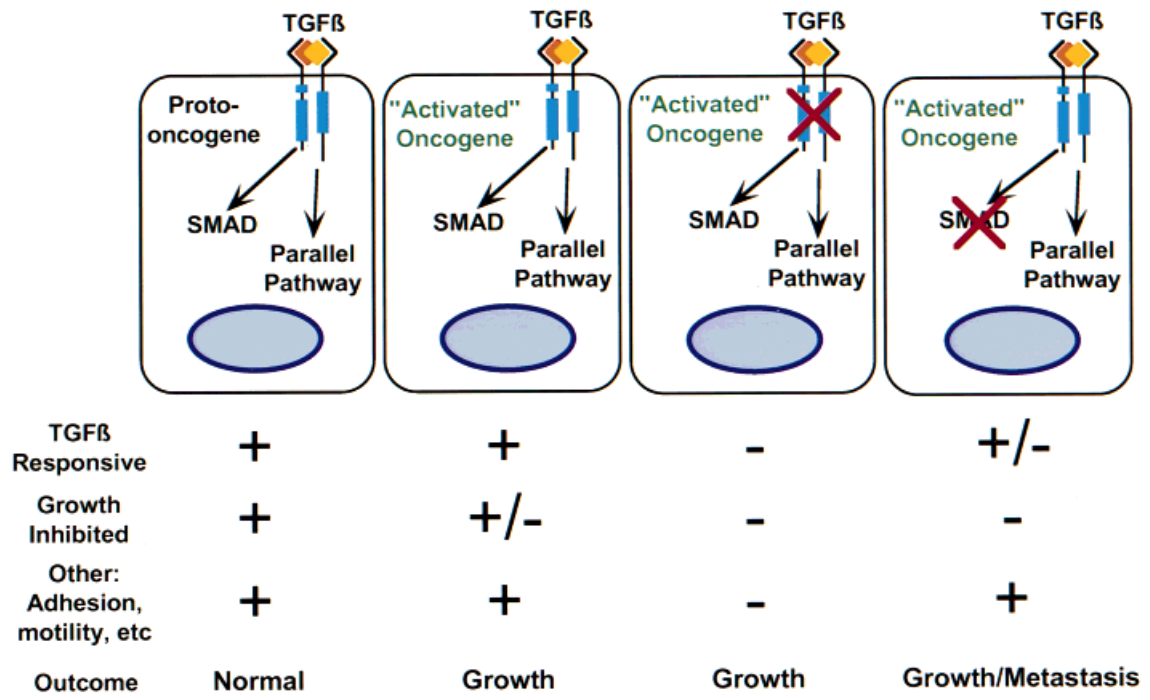

Fig. 4. Engel et al. From page 120.

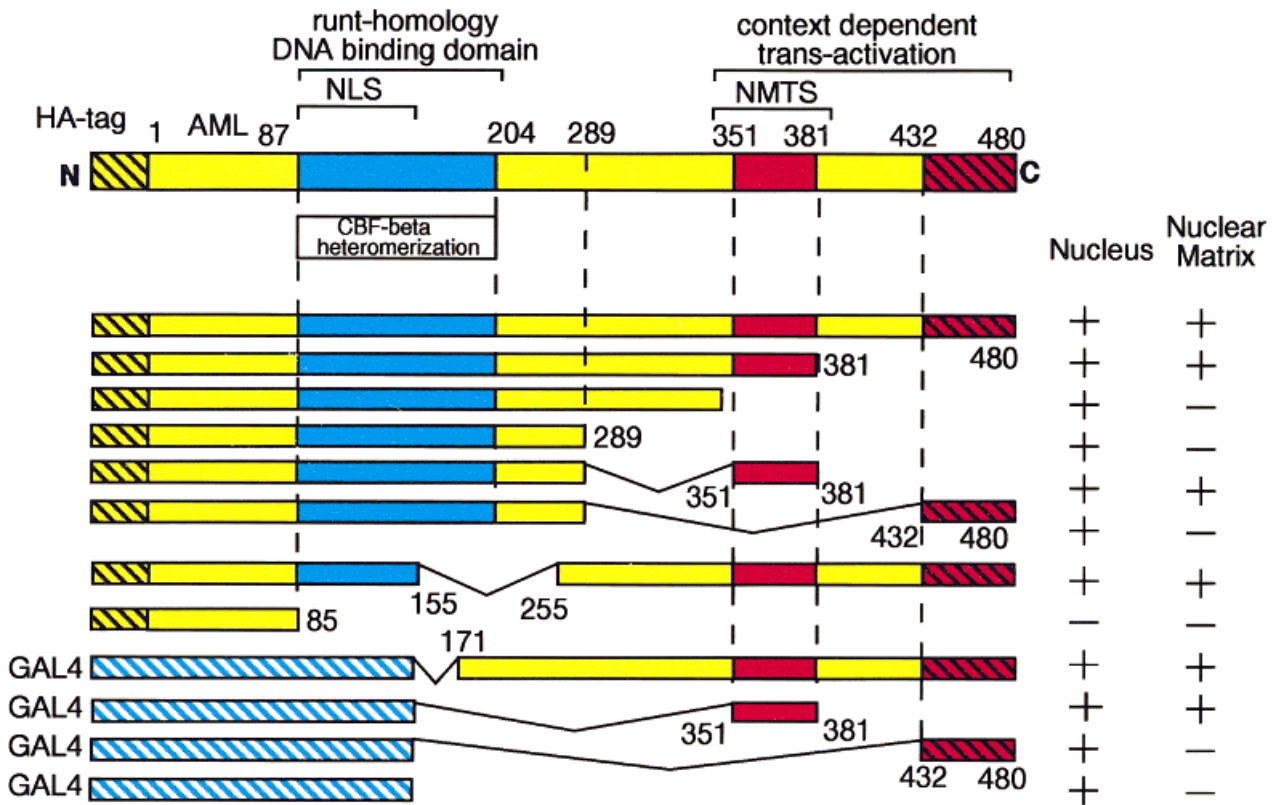

Fig. 1. Stein et al. From page 224.

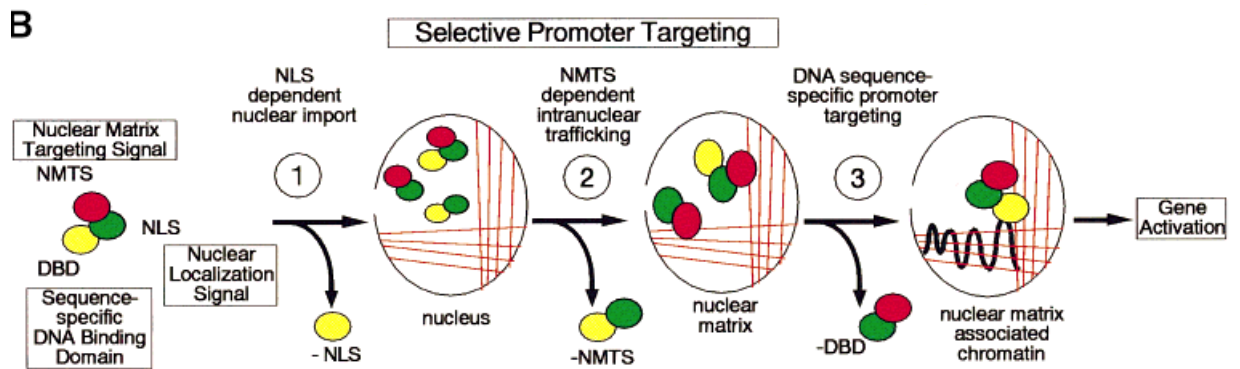
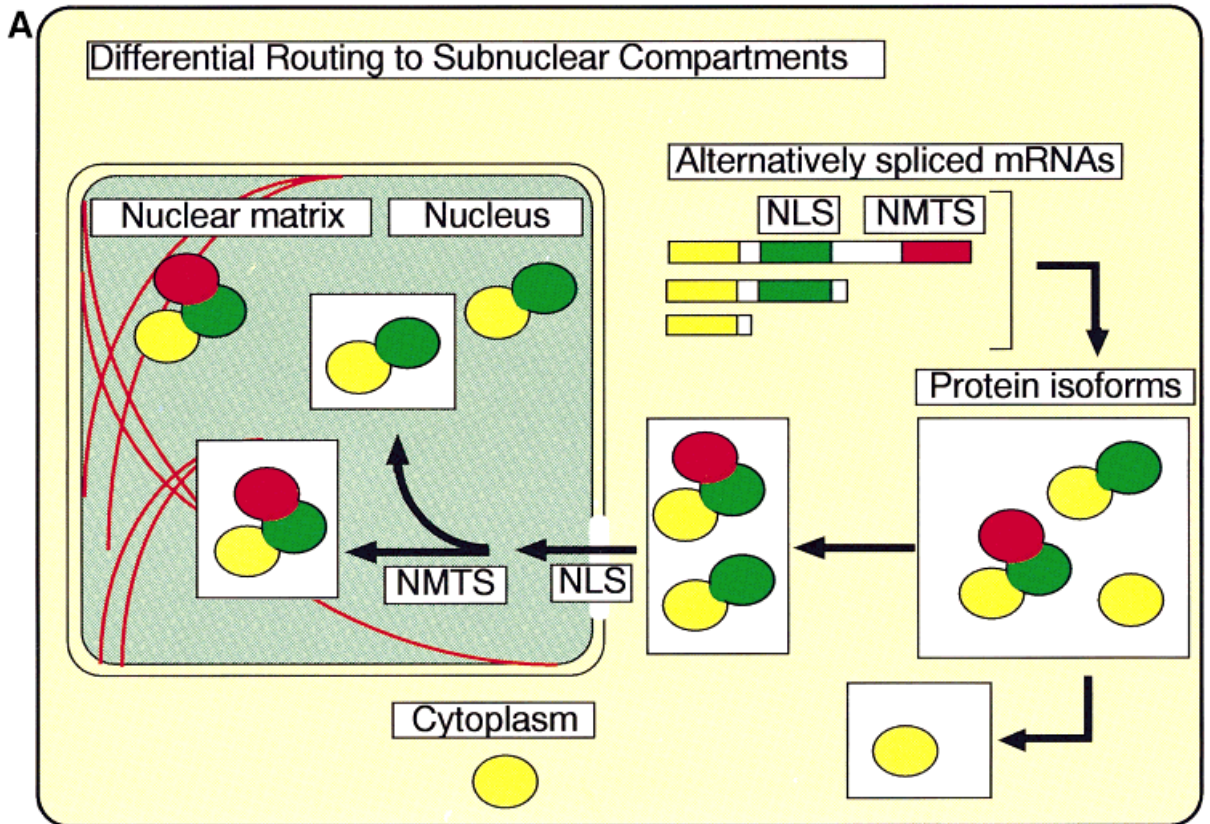

Fig. 2. Stein et al. From page 225.

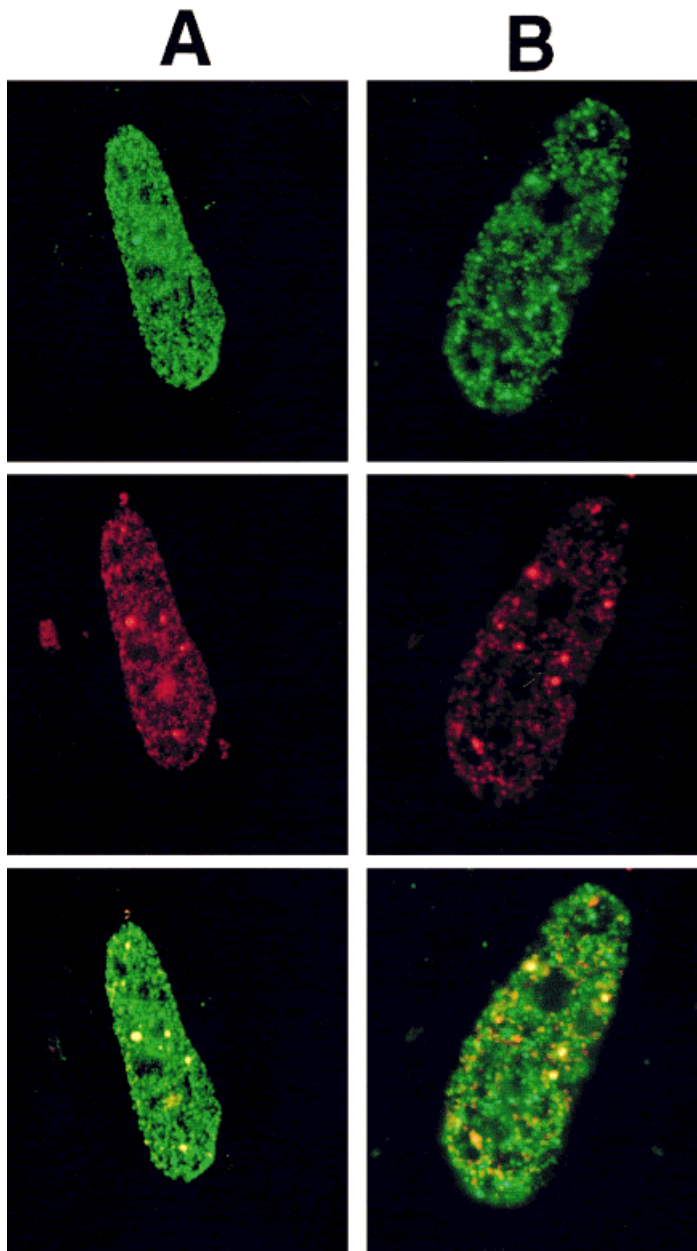

Fig. 3. Stein et al. From page 226.

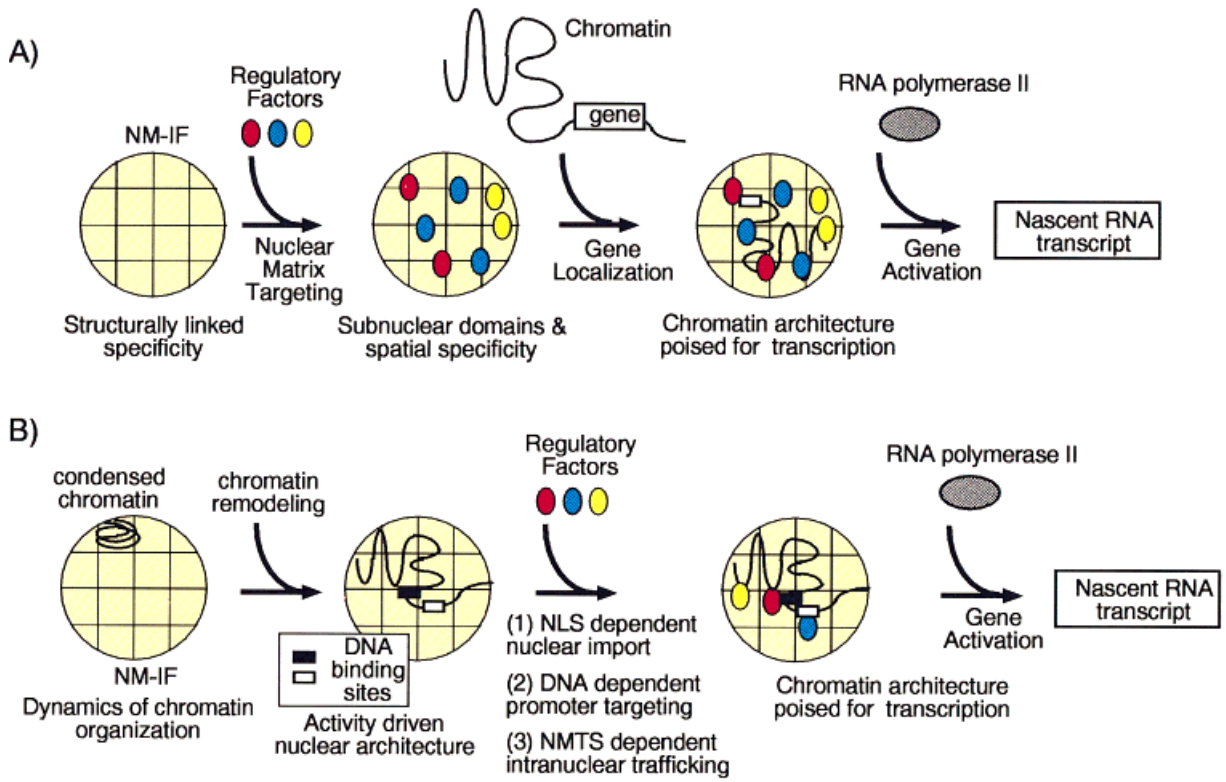

Fig. 4. Stein et al. From page 228.

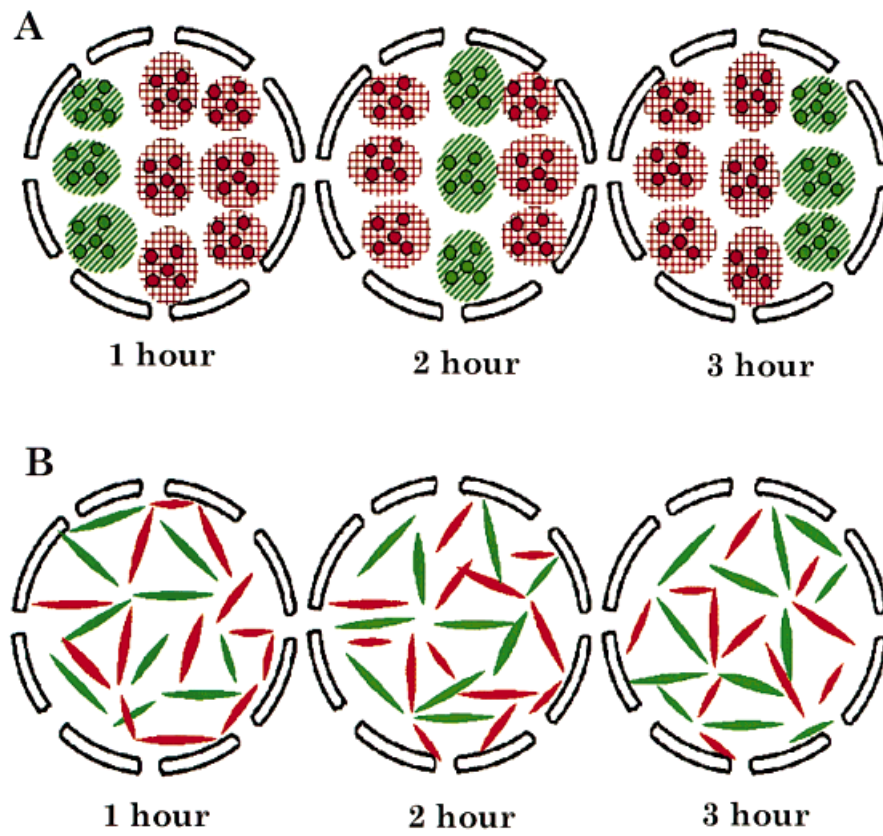

Fig. 3. Berezney and Wei. From page 241.

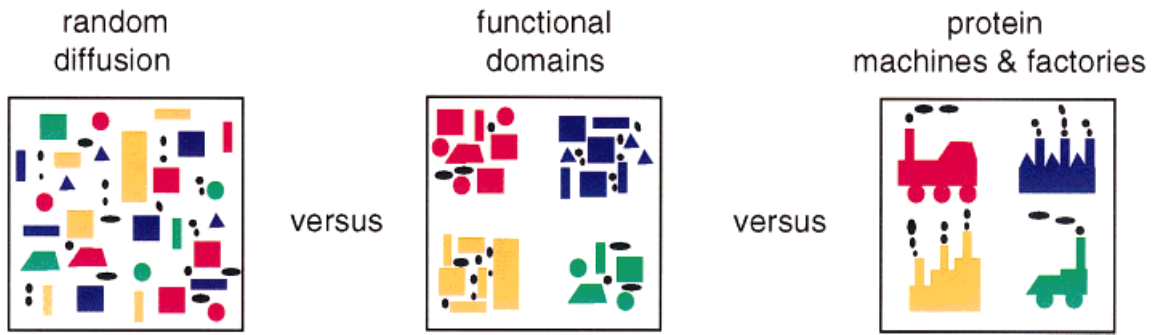

Fig. 1. Leonhardt et al. From page 244.

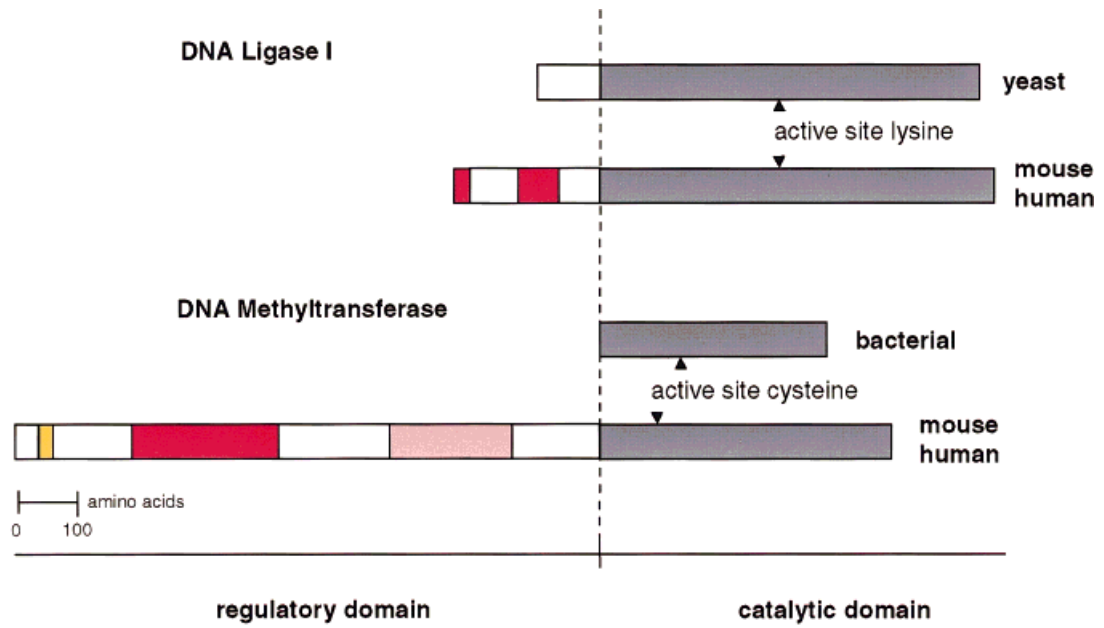

Fig. 2. Leonhardt et al. From page 245.

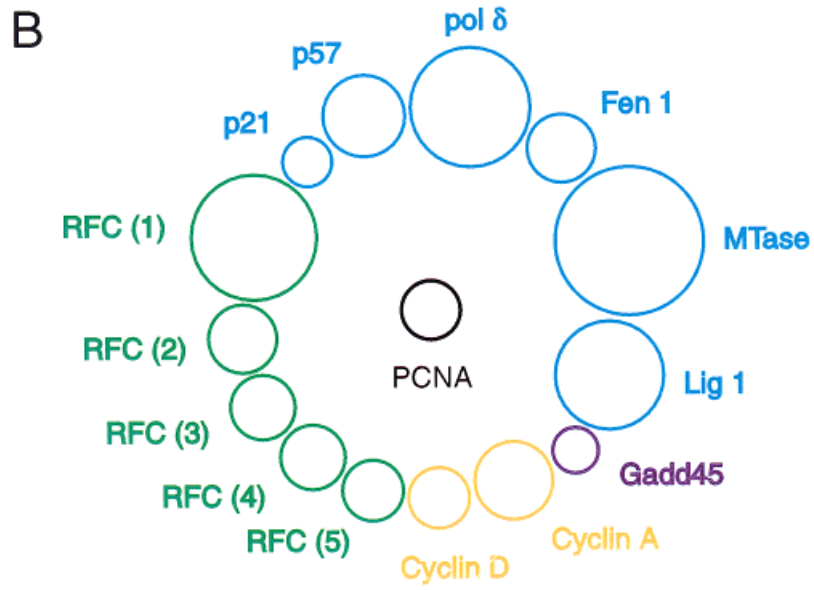
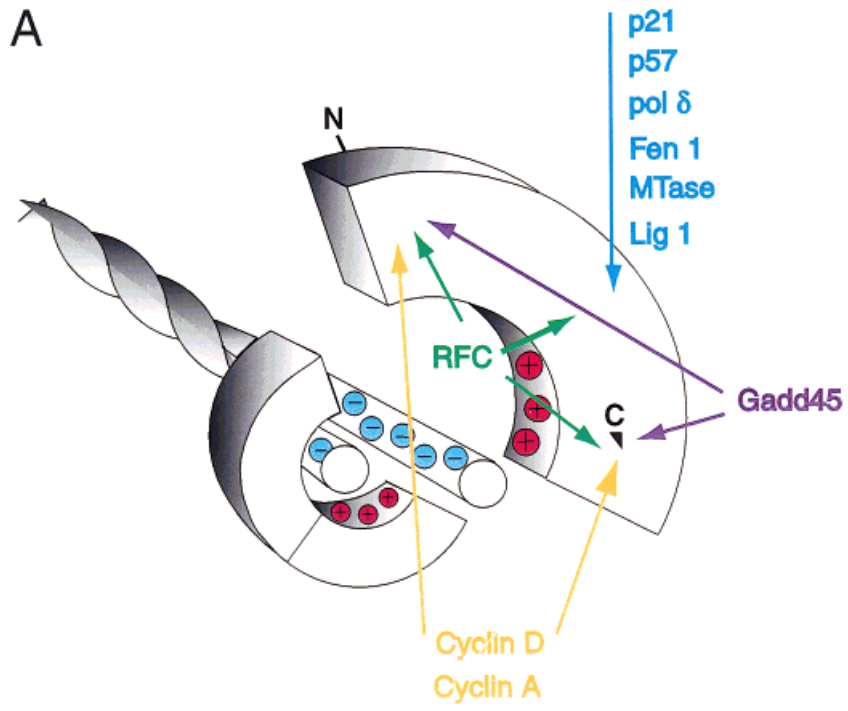

Fig. 3. Leonhardt et al. From page 247.



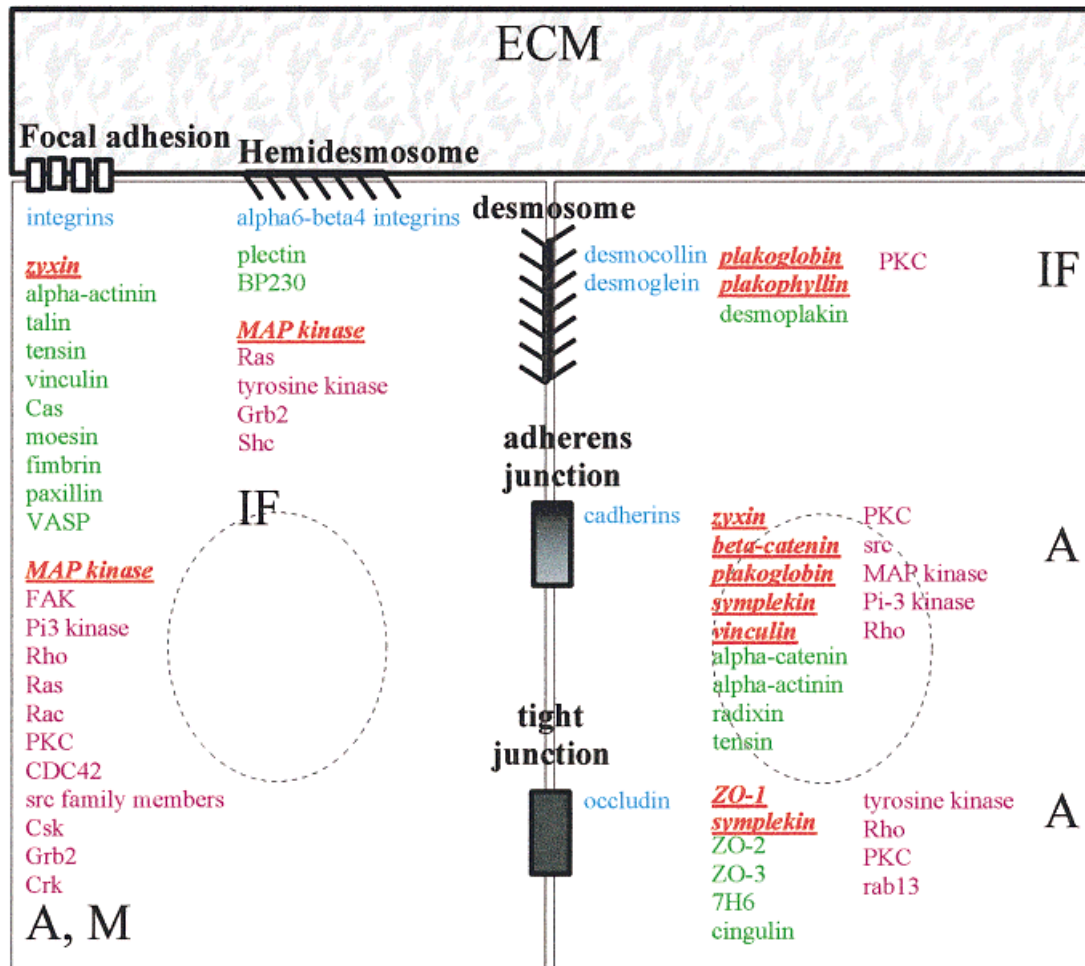

Fig. 1. Lelièvre and Bissel. From page 252.

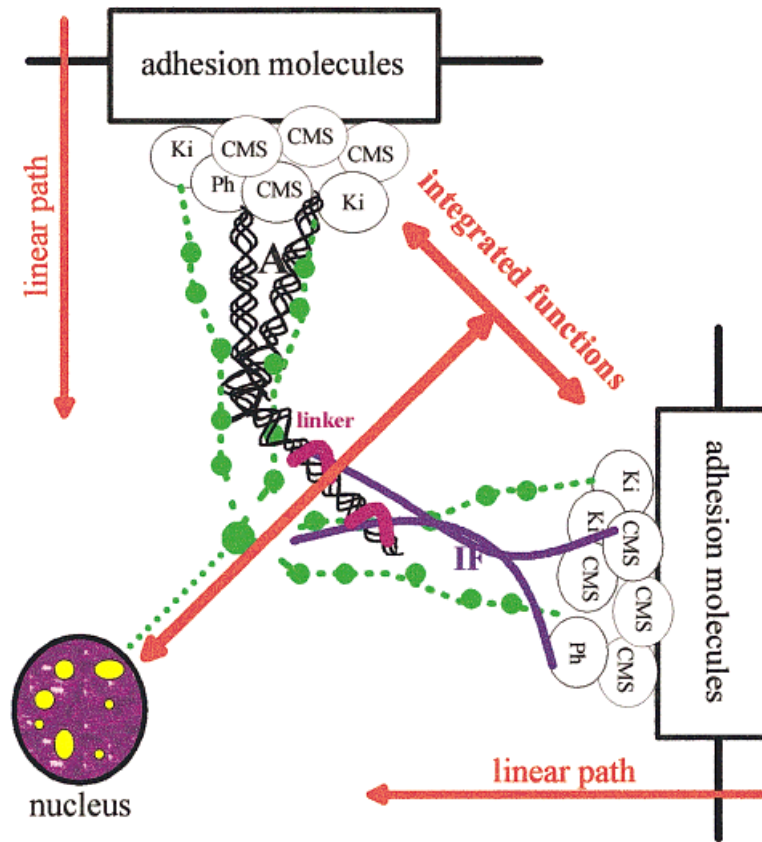

Fig. 2. Lelièvre and Bissel. From page 253.

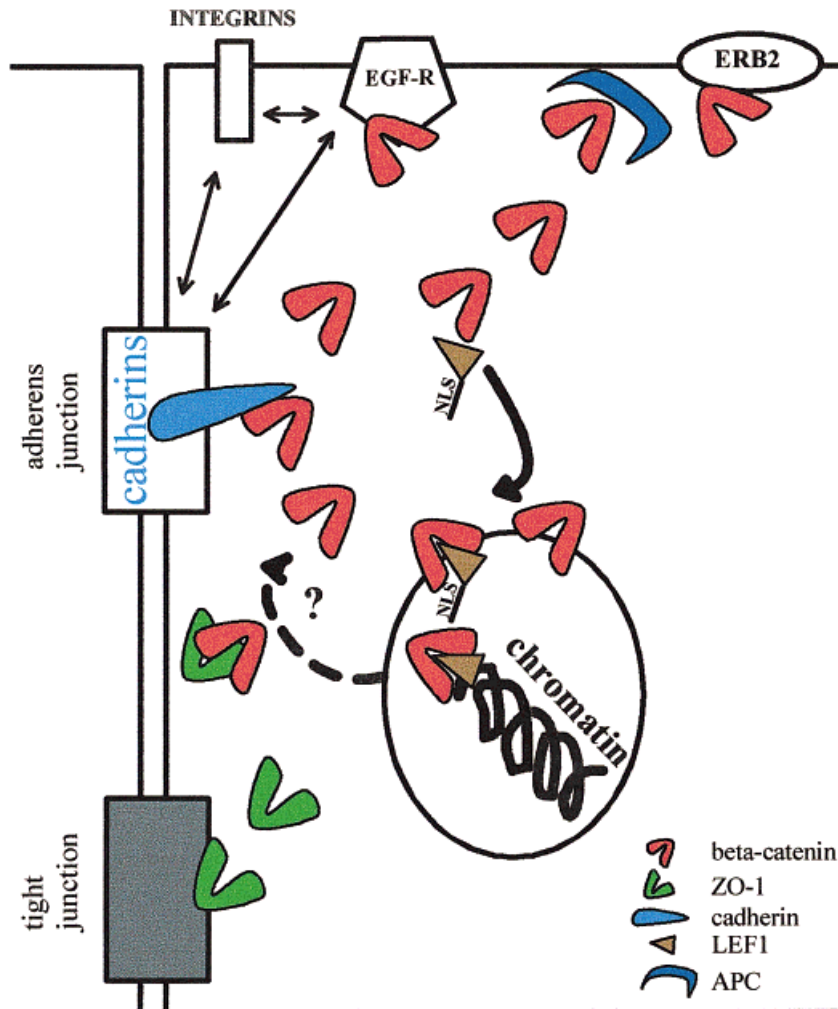

Fig. 3. Lelièvre and Bissel. From page 257.

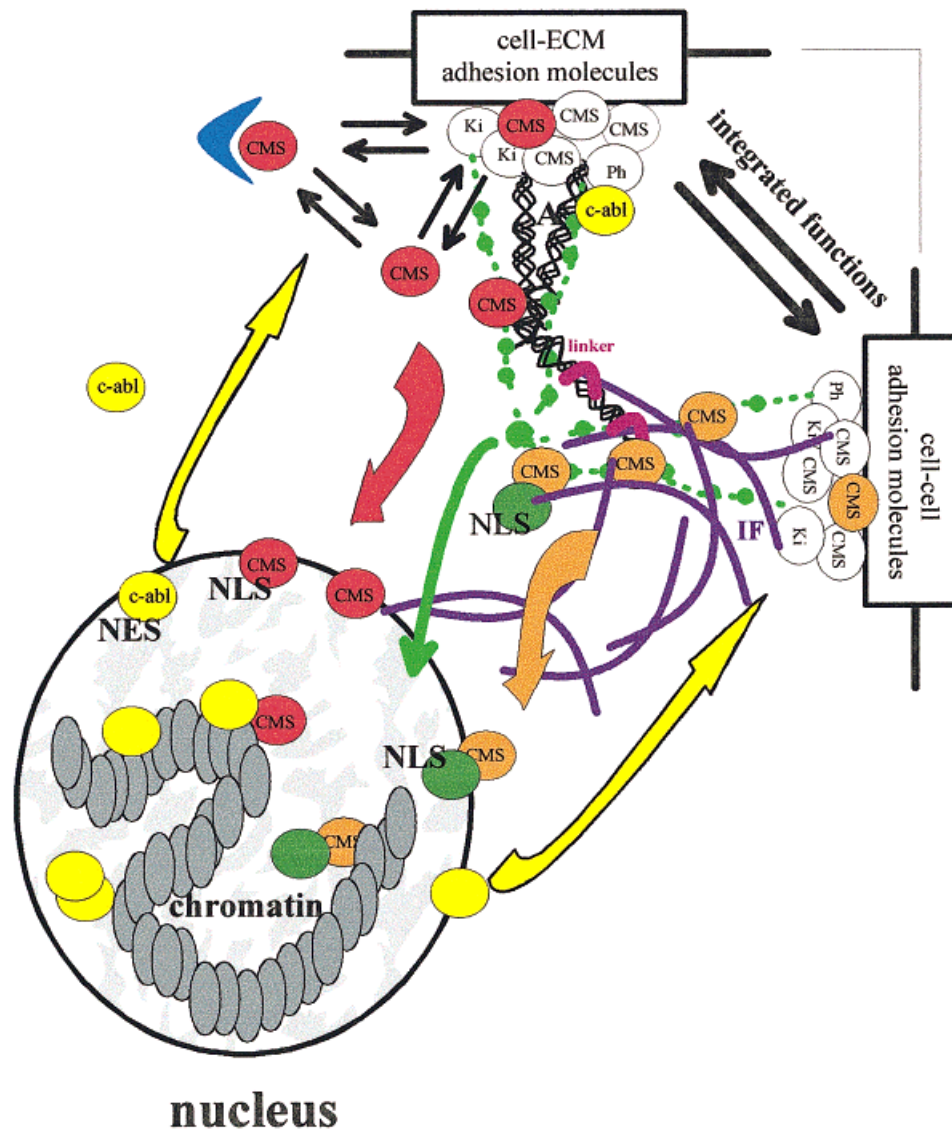

Fig. 4. Lelièvre and Bissel. From page 258.

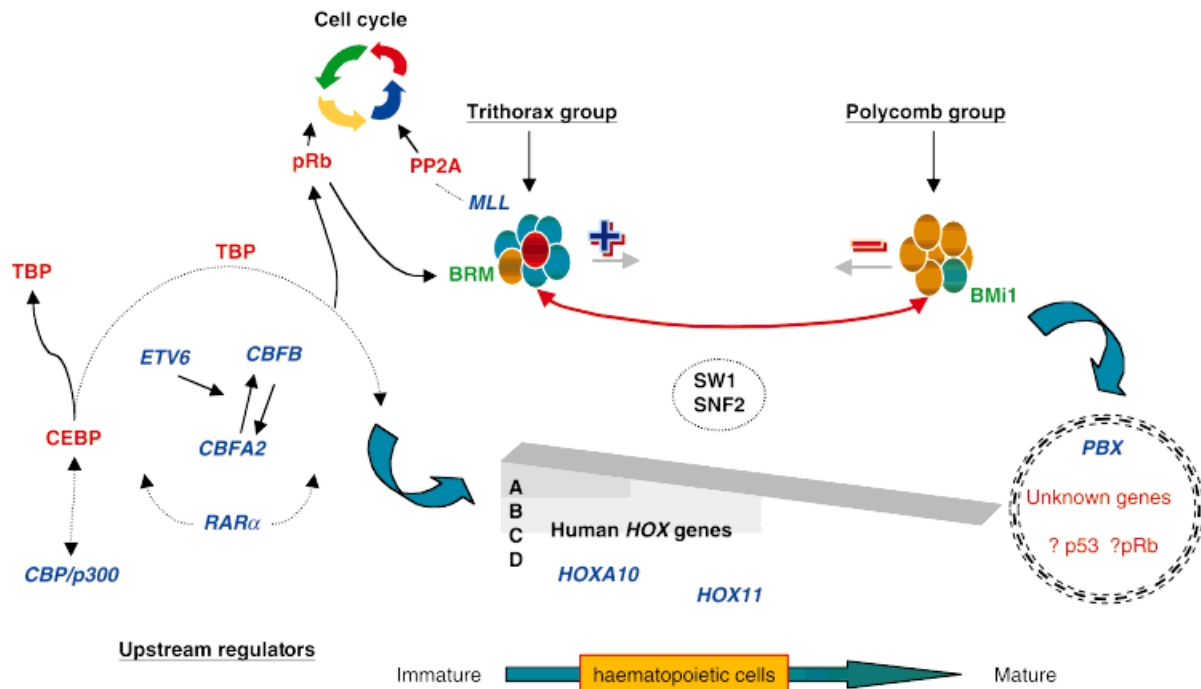

Fig. 1. Saha et al. From page 267.

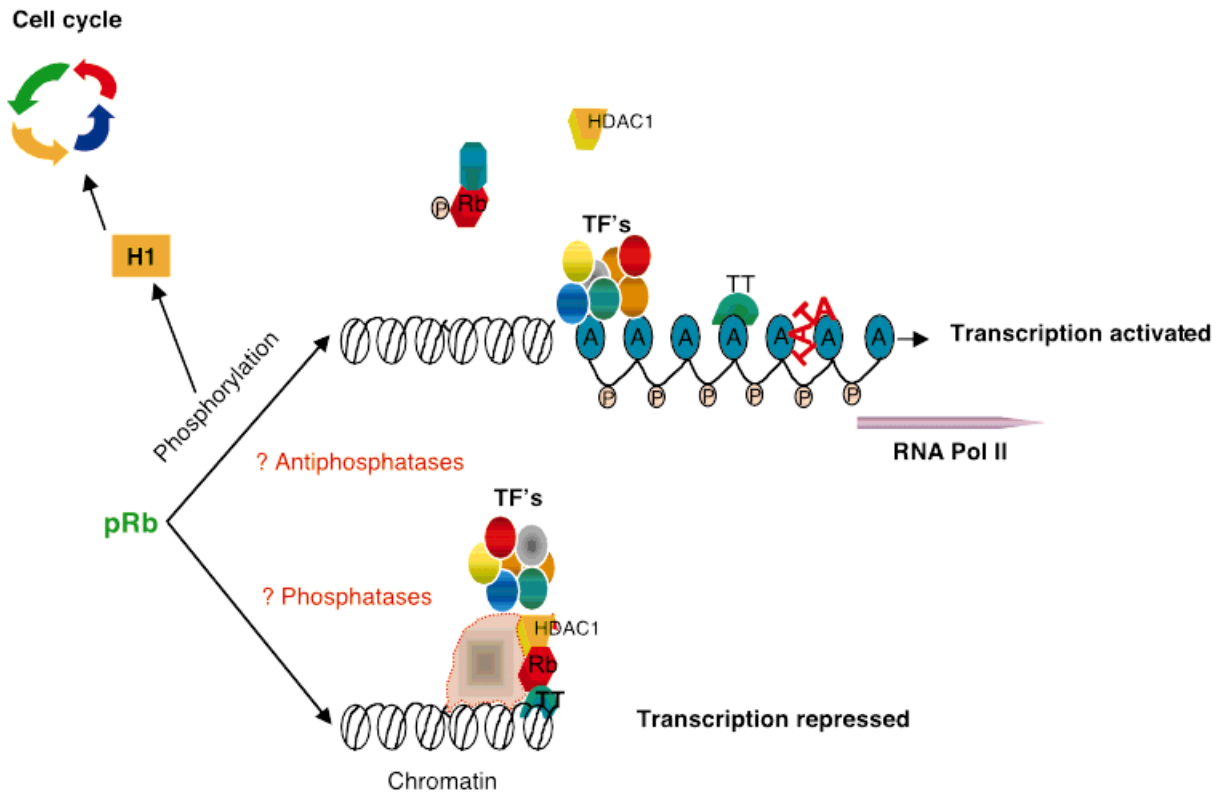

Fig. 2. Saha et al. From page 272.

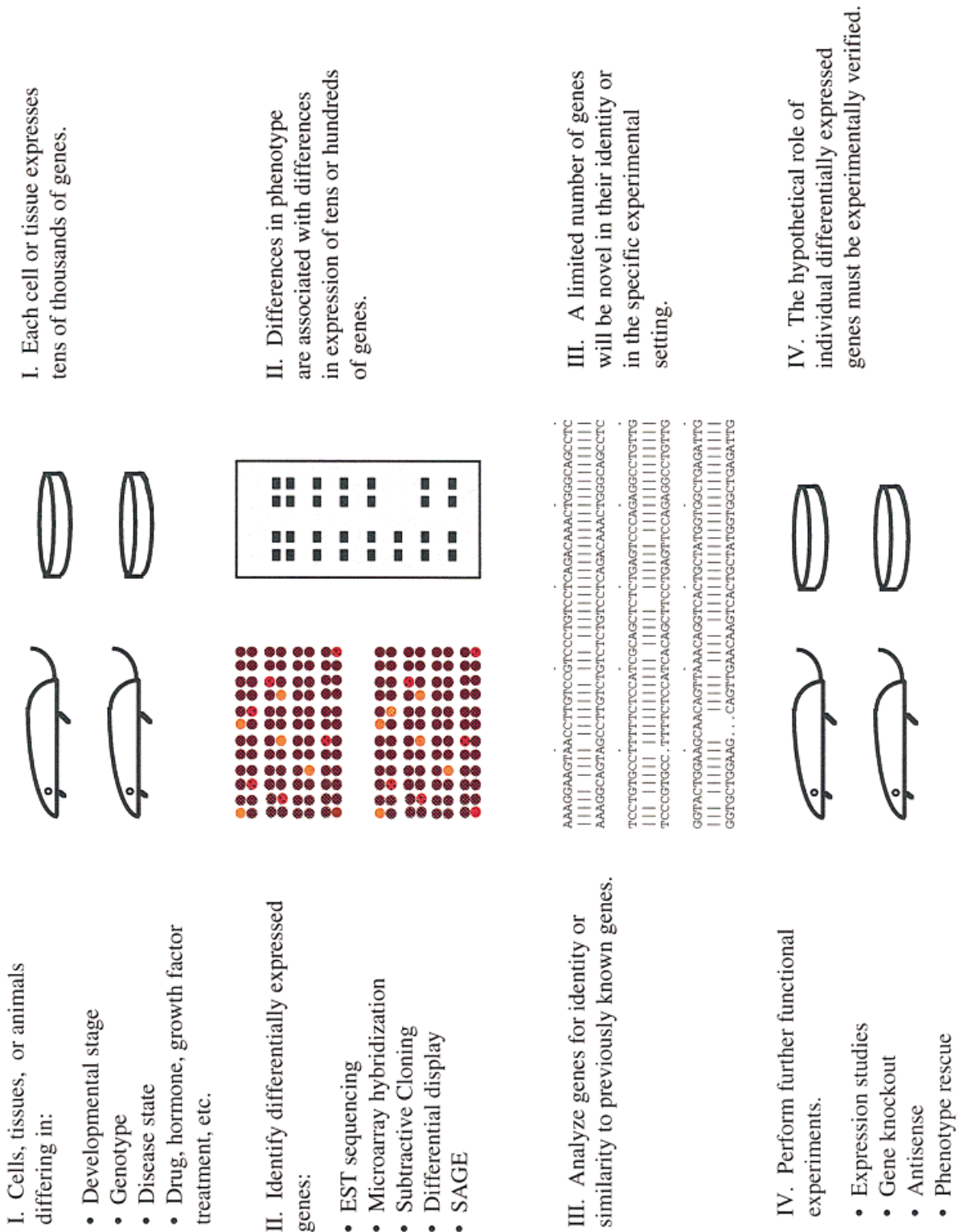

Fig. 1. Carulli et al. From page 287.

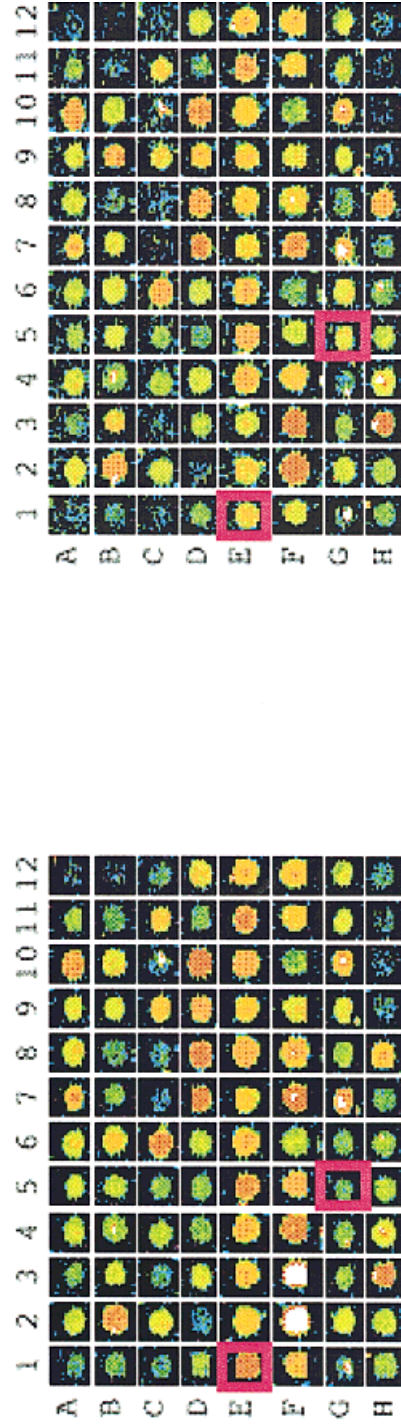
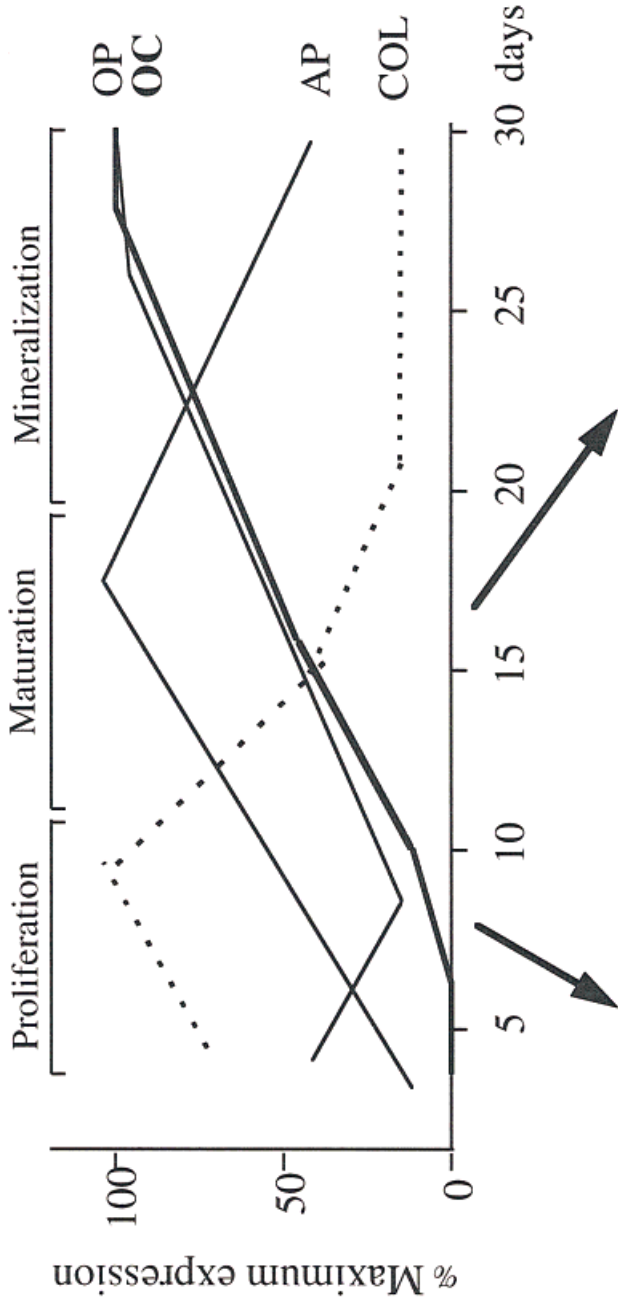

Fig. 2. Carulli et al. From page 289.

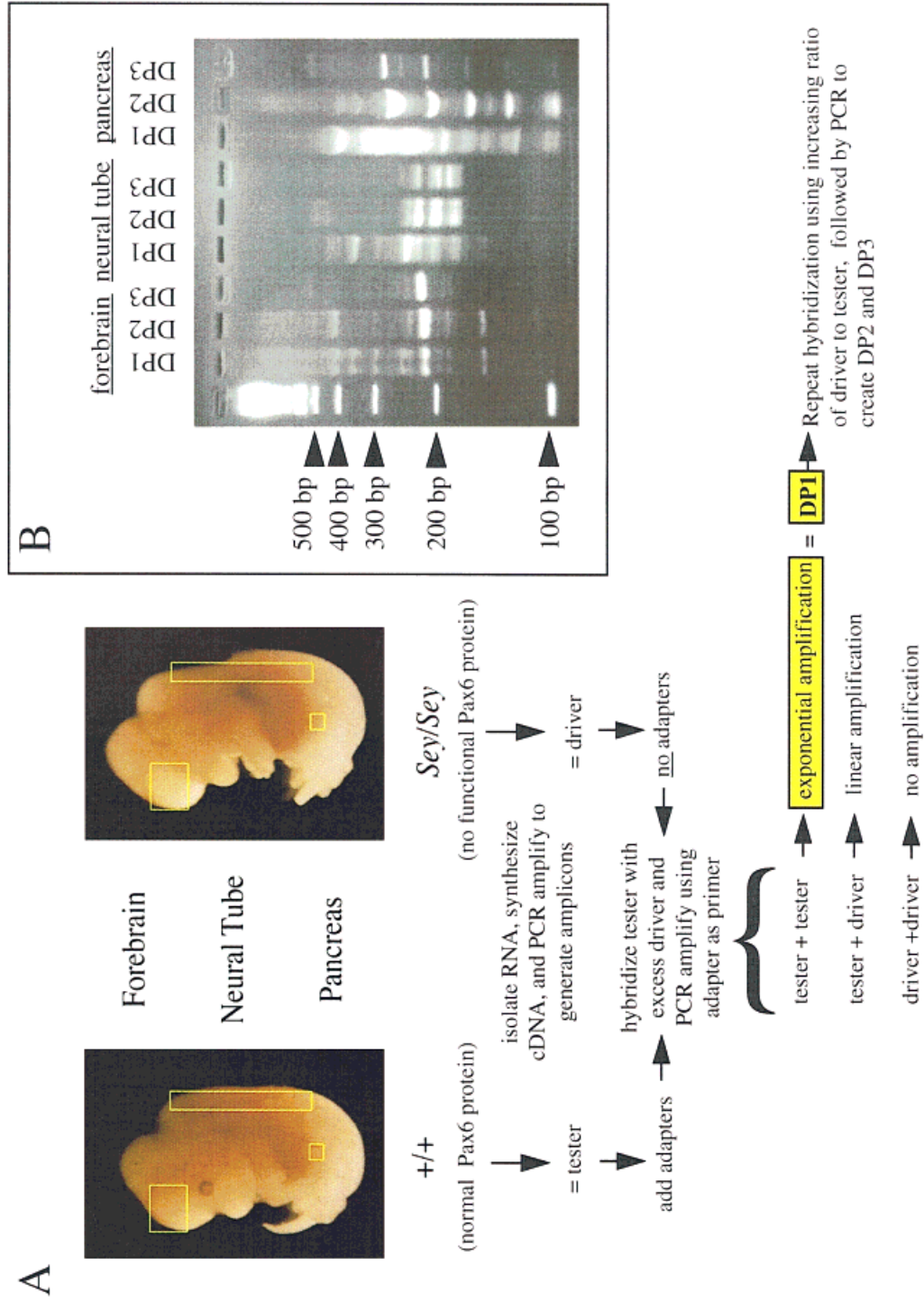

Fig. 3. Carulli et al. From page 292.

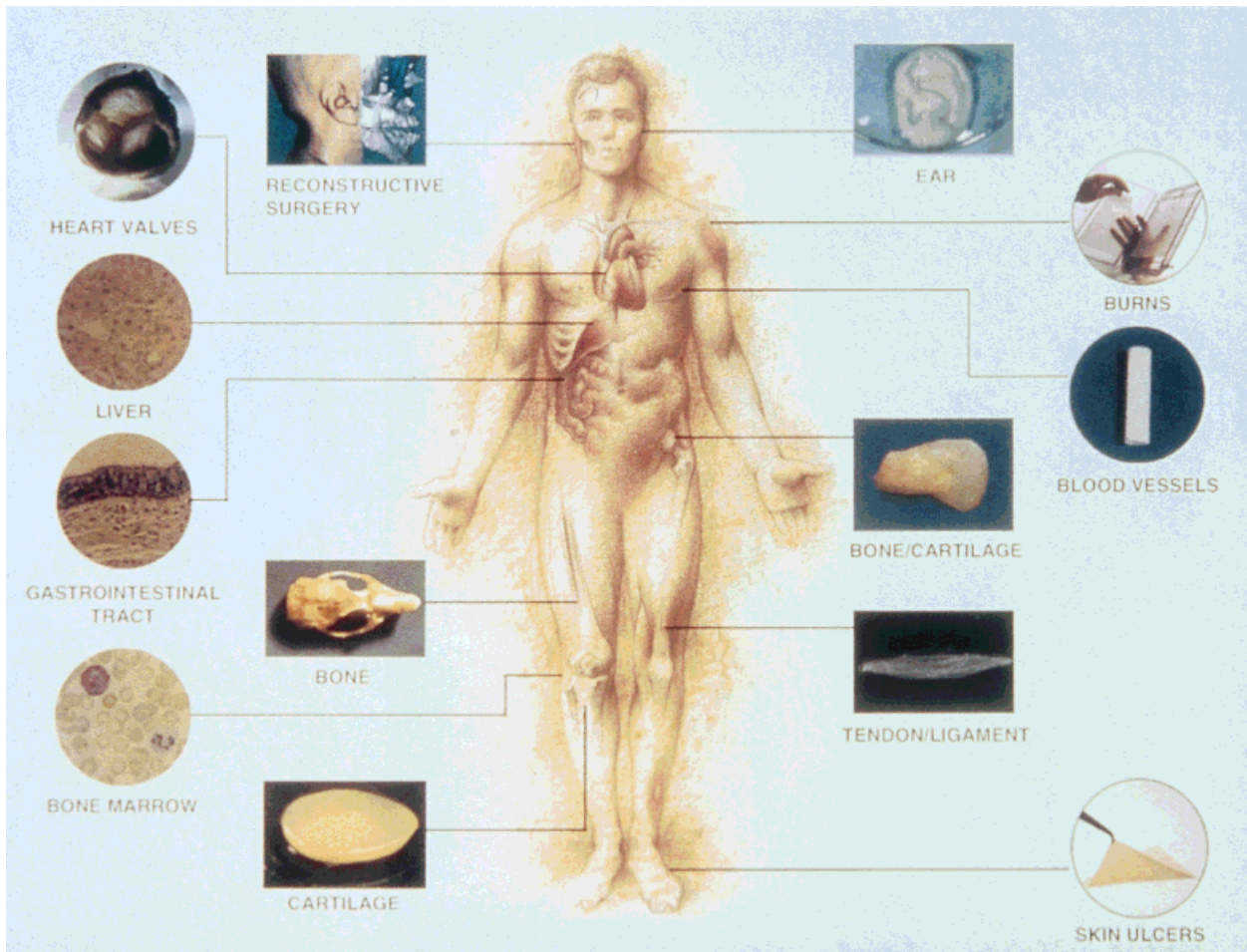

Fig. 1. Bonassar and Vacanti. From page 298.